

Opis znaczeń kolorów:

Linia czerwona : przesywana i ciągła minimalny otwór w stropie, wymiary w mm.

Linia czarna: długość i szerokość zabiegu schodów

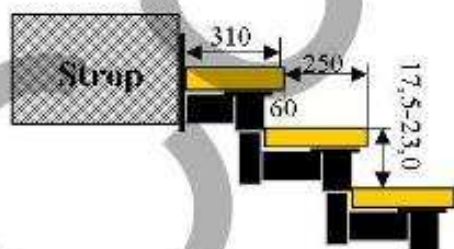
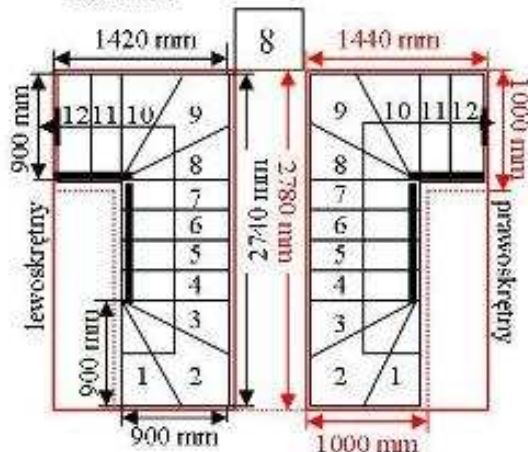
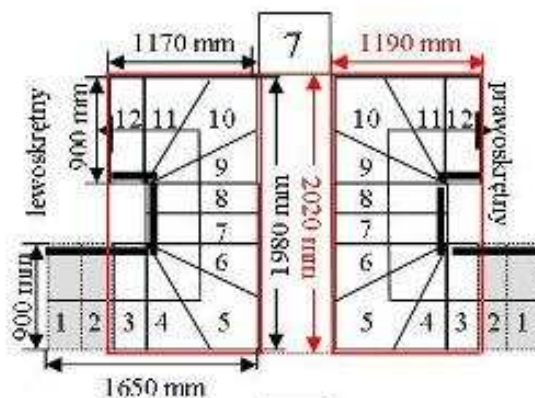
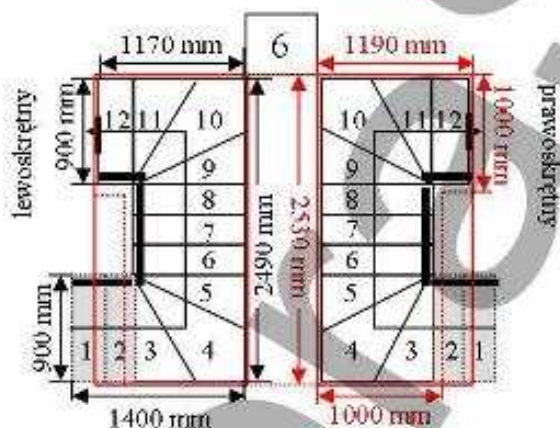
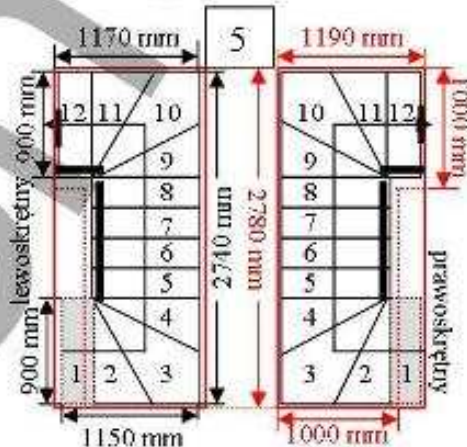
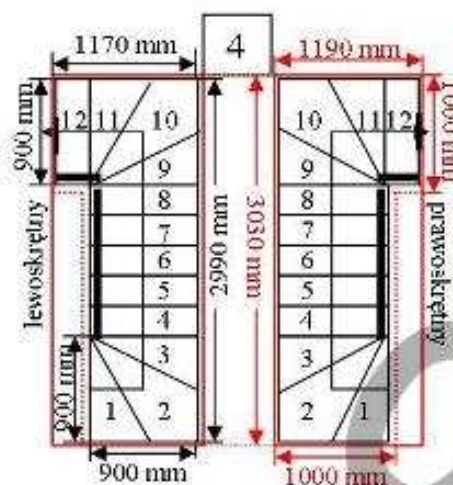
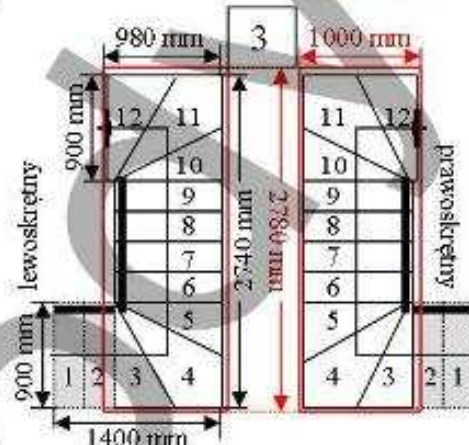
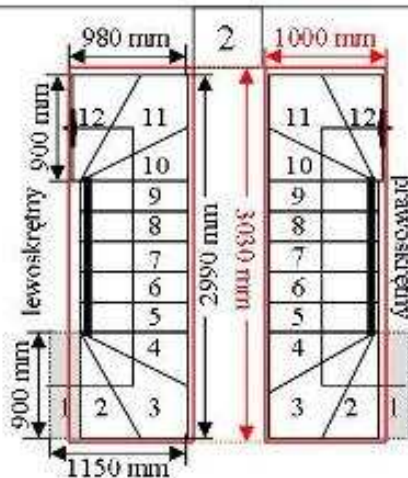
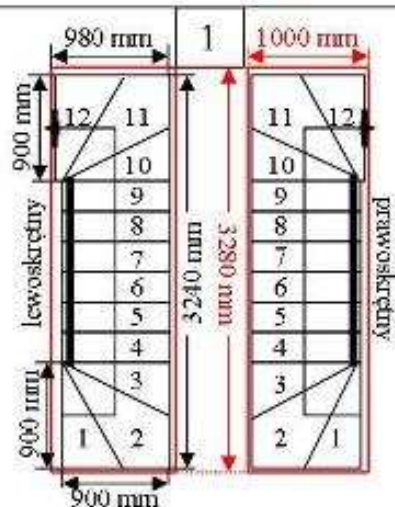

Opis znaczeń kolorów:

Linia czerwona : ciągła i przerywana minimalny otwór w stropie, wymiary w mm,  
 Linia czarna: długość i szerokość biegu schodów w mm,

